

THE

# General Radio EXPERIMENTER

VOLUME XIV NO. 2

JULY, 1939

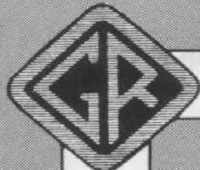

ELECTRICAL MEASUREMENTS AND THEIR INDUSTRIAL APPLICATIONS

*Also*

### IN THIS ISSUE

	<i>Page</i>
IMPROVED TYPE 100 VARIAC . . . . .	3
A VARIAC WITH LOW-VOLTAGE OUTPUT . . . . .	4
CRANKSHAFT VIBRATION MEASUREMENTS WITH THE SOUND ANALYZER . . . . .	6

## NEW MODELS OF THE VARIAC

• WITH THE TWO NEW MODELS of the Variac now available, the amount of power controllable by a single unit is more than doubled. TYPE 50-A, for 115-volt service, will handle 5 kva, and TYPE 50-B, operating at 230 volts, will handle 7 kva. Because of their high power-handling capacity, the TYPE 50 Variacs find many industrial applications where failure would be serious and where they are subjected to considerable

abuse. Consequently, much effort in the design has been directed toward making as rugged, reliable and serviceable a unit as possible.

FIGURE 1. View of the TYPE 50-B Variac with cover.



**BRUSH ASSEMBLY**

Among the features contributing to reliability is the brush assembly. Six independent carbon brushes are used, each in a brass holder. The two springs that hold each brush in place are sufficiently long to assure uniform tension as the brushes wear.

The brushes are mounted on a cast-aluminum radiator, so shaped as to conduct heat rapidly from the region of the brushes to cooler regions where it can be radiated easily. To assure low resistance connections, each brush holder is connected electrically to the radiator through a flexible copper lead. Connection from the radiator to the Variac terminal is made through a pigtail lead.

**WINDING AND CORE**

The winding form is molded with radial slots to hold each turn firmly in

place and insure the maintenance of a good commutator surface. As in other Variacs, the core is toroidal, built up of ring-shaped laminations.

**MOUNTING**

TYPE 50 Variac is suitable for either table or panel mounting. The base is of cast iron with four feet drilled for mounting with 1/2-inch bolts on a 7 1/4-inch radius. The 3/4-inch shaft is held by two setscrews. To convert the Variac for panel mounting, the setscrews are loosened and the shaft pushed through to the desired position.

**TERMINALS**

Two terminal plates are provided, one for input connections, the other for output. Both are protected by the cover.

**COVER**

A perforated brass housing covers the winding, brushes, terminals, etc. Two

FIGURE 2. TYPE 50-B Variac with cover removed.

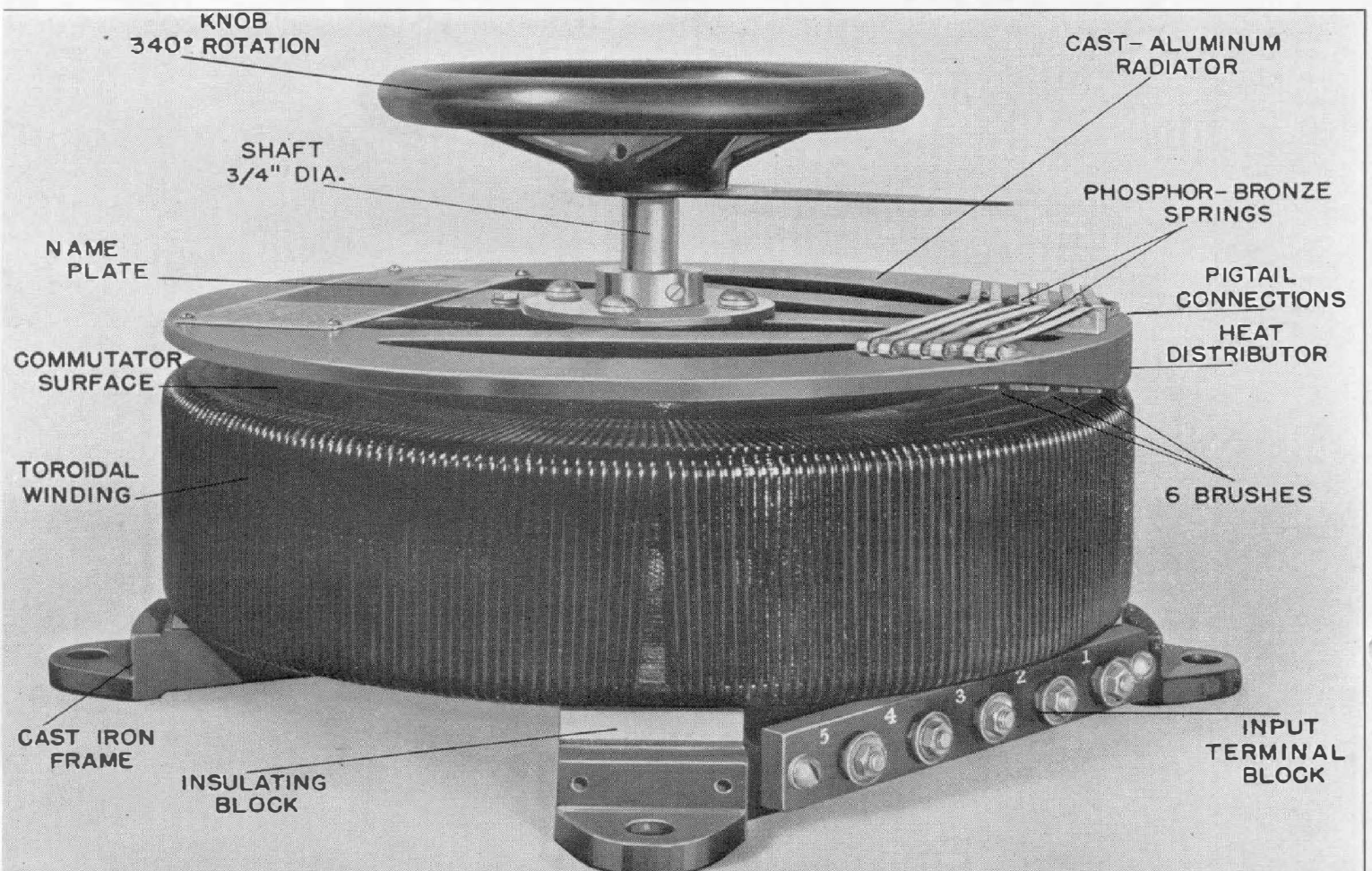

handles for lifting the Variac are provided. Both a name plate and a dial are mounted on this brass cover.

**DIAL**

The dial is two-sided and reads output voltage directly in terms of a 115-volt input for TYPE 50-A, or 230-volt input for TYPE 50-B. One side of the dial is used when the Variac is connected to give a maximum output voltage equal to line voltage; the other side is used when the connections are for 135-volt output

on the TYPE 50-A or 270 volts on the TYPE 50-B.

**NAME PLATE**

The name plate carries a circuit diagram and brief operating instructions. As is shown in the photographs, two name plates are provided. One is mounted on the cover, the other on the radiator.

— S. A. BUCKINGHAM

**SPECIFICATIONS**

Type	50-A	50-B (230 v in)	50-B (115 v in)
Load Rating*	5000 va	7000 va	2300 va
Rated Current	40 a	20 a	10 a
Maximum Current	45 a	31 a	31 a
Input Voltage	115 v	230 v	tapped for 115 v
Output Voltage	{0-115 v 0-135 v}	{0-230 v 0-270 v}	0-230 v
No-Load Loss†	60 watts	75 watts	75 watts
Line Frequency‡	60 cycles	60 cycles	60 cycles
Dimensions: 13 <sup>5</sup> / <sub>8</sub> x 13 <sup>5</sup> / <sub>8</sub> x 9 <sup>3</sup> / <sub>8</sub> inches, over-all.			
Net Weight: 75 pounds.			

\*Ratings are for 50° C. temperature rise, with cover.

†At 60 cycles.

‡These Variacs can be operated at 50 cycles with slightly more heating or slightly reduced rating.

Type		Code Word	Price
50-A	Variac.....	TOKEN	
50-B	Variac.....	TOPAZ	

**IMPROVED TYPE 100 VARIAC**

● THE 2-KVA VARIACS, TYPES 100-K and 100-L, have recently been replaced by new models, TYPE 100-Q and TYPE 100-R, respectively. Most important change is the provision for over-voltage output; the TYPE 100-Q will give a maximum output of 135 volts and the TYPE 100-R, 270 volts. The height of the core and, consequently, the over-all height of the Variac have been increased, but all other dimensions remain unchanged.

Pigtails have been added to the brush

holders to give better electrical contact between brush and radiator. This has resulted in a lower brush temperature with consequent increase in brush life. Longer brush springs help to keep the force between brush and winding constant as the brush wears.

A two-sided dial, reading directly in output voltage, is provided for each model. One side is used for maximum output voltage equal to input line voltage; the other side is for the over-voltage connection.

A slight increase in the rated current has been made possible by the new design. See specifications for details.

The terminal plate (see Figure 1 below) carries a wiring diagram of the

internal connections so that the work of installing and wiring the Variac is simplified. The number of turns between taps on the winding is also given. This makes it possible to determine whether or not the rating (voltage per turn) is exceeded in unusual applications.

—S. A. BUCKINGHAM

SPECIFICATIONS

Type	100-Q	100-R (230 v in)	100-R (115 v in)
Load Rating	2 kva	2 kva	1 kva
Rated Current	18 a	9 a	4.5 a
Maximum Current	18 a	9 a	9 a
Input Voltage	115	230	tapped for 115
Output Voltage	{0-115 0-135}	{0-230 0-270}	0-230
No-Load Loss*	20 watts	25 watts	25 watts
Dimensions:	7 <sup>3</sup> / <sub>4</sub> x 9 x 7 <sup>5</sup> / <sub>8</sub> inches.		
Net Weight:	29 pounds.		

\*At 60 cycles.

Type	Code Word	Price
100-Q Variac.....	BEAMY	
100-R Variac.....	BEARD	

FIGURE 1. View of the new TYPE 100 Variac, showing the terminal plate.

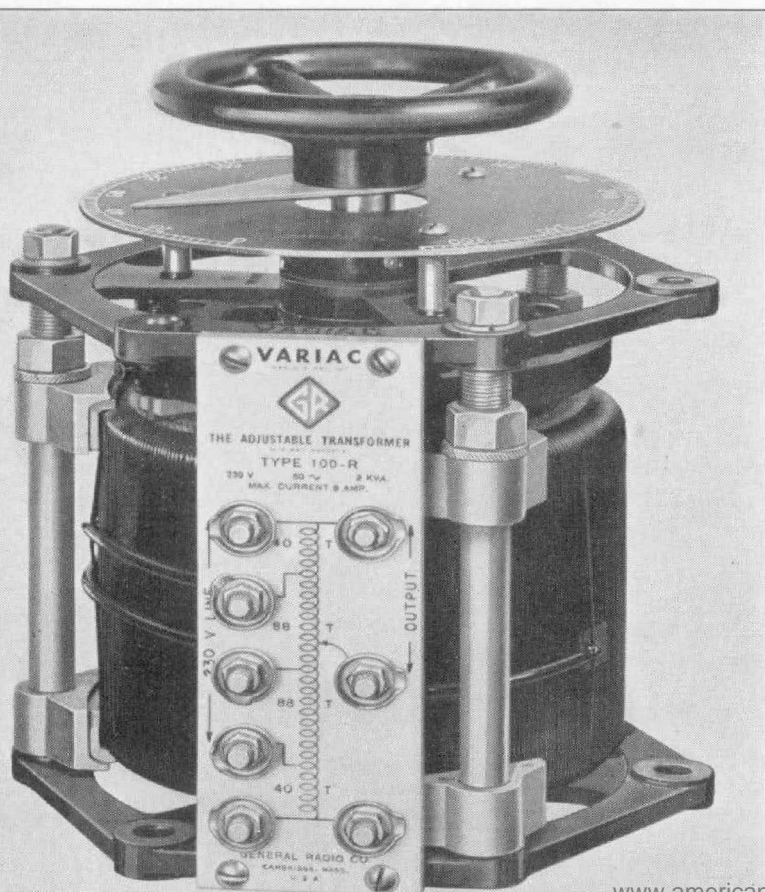

A VARIAC WITH LOW-VOLTAGE OUTPUT

• ANOTHER RECENT ADDITION to the Variac line is the TYPE 90-B. This unit, which consists of a TYPE 200-B Variac and a step-down transformer, is extremely useful in the communication laboratory as a source of cathode power for vacuum tubes. Figure 1, page 5, is a photograph of the TYPE 90-B Variac; Figure 2 shows the internal connections.

From the built-in TYPE 200-B Variac itself, 0 to 135 volts can be obtained. From the auxiliary transformer, which is controlled by the Variac, the two com-

monly used cathode heater voltages are available. Two secondaries are provided for each voltage. The actual voltages are 7.4 and 2.9 volts for use on 6.3- and 2.5-volt circuits, respectively.

(Right) FIGURE 1. The TYPE 90-B Variac. The binding posts are the low-voltage terminals. The output of the TYPE 200-B Variac is available at the plug receptacle.

(Below) FIGURE 2. Wiring diagram of TYPE 90-B Variac. Note that independent windings are used for the low-voltage circuits.

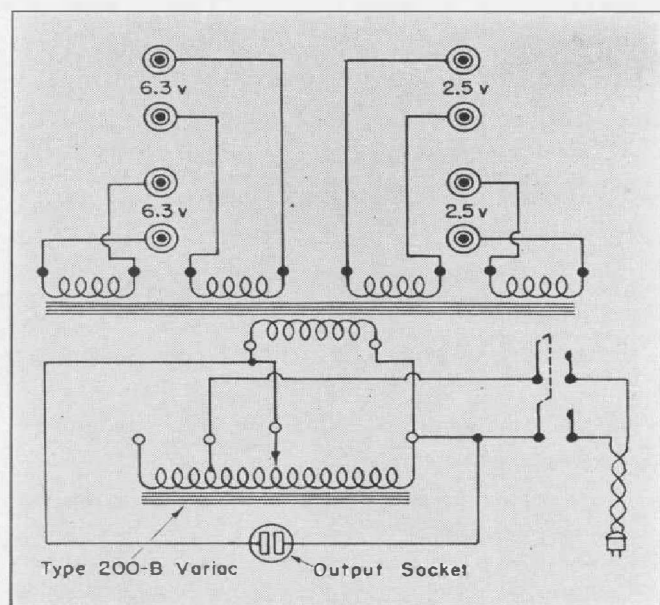
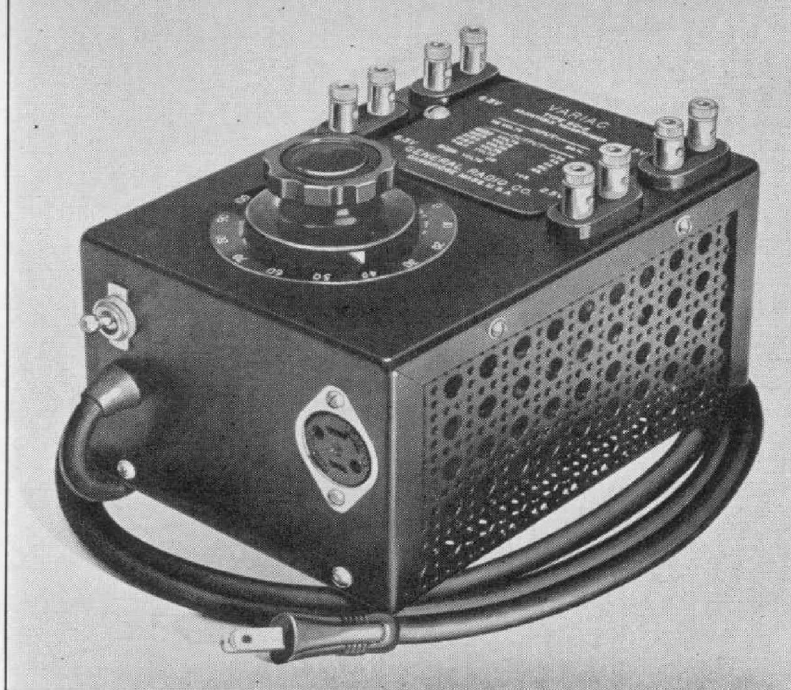

### SPECIFICATIONS

- Load Rating: \*170 va, total.
- Input Voltage: 115.
- Output Voltage: 0-135, 0-7.4, 0-2.9
- Rated Current: 1 a, 4 a, 4 a
- Maximum Current: 1.5 a, 4 a, 4 a
- No-Load Loss: 8 watts
- Dimensions: 7¼ x 5 x 6 inches, over-all.
- Net Weight: 8¾ pounds.

\*With all secondaries operating at once, 82 watts can be drawn from the low-voltage circuits and 70 va from the Variac output.

Type	Code Word	Price
90-B	Variac.....	PIVOT

## THE SERVICE DEPARTMENT SAYS:

● THE SUMMER MONTHS, when instruments used in educational and industrial laboratories are idle for considerable periods because of staff vacations, offer an excellent opportunity to

have instruments reconditioned and repaired with minimum interruption to the laboratory program. Before returning instruments for repair, please communicate with the Service Department.

## CRANKSHAFT VIBRATION MEASUREMENTS WITH THE SOUND ANALYZER

● **BEHIND THE MARKED IMPROVEMENT** in the smoothness and quietness of the automobile which has taken place in the last few years is a continuous program of research carried out in the laboratories of automotive manufacturers. An important factor in the success of this program is the increasing availability of instruments for measuring mechanical and electrical qualities. Not only are rule-of-thumb and guesswork rapidly giving way to accurate measurement, but the speed and ease of measurement are being improved. The measurement of torsional vibration in crankshafts is a good example.

In the accepted method of measuring the amplitudes of the components of

torsional vibration, an oscillogram of the vibration wave is analyzed on a mechanical harmonic analyzer. The oscillogram is obtained from the amplified output of a vibration pickup mounted on the shaft to be measured. Because the mechanical method is excessively time-consuming, there has been considerable interest in the TYPE 760-A Sound Analyzer as a faster and more convenient means of making the measurement. This analyzer operates directly from the amplifier output of the vibration pickup and does not require an oscillogram. The amplitude of each component is measured directly, simply by turning the frequency dial and reading the deflection on the meter.

A series of measurements made on an

FIGURE 1. The TYPE 760-A Sound Analyzer set up for measuring torsional vibration. The pickup on the end of the crankshaft is at the extreme left.

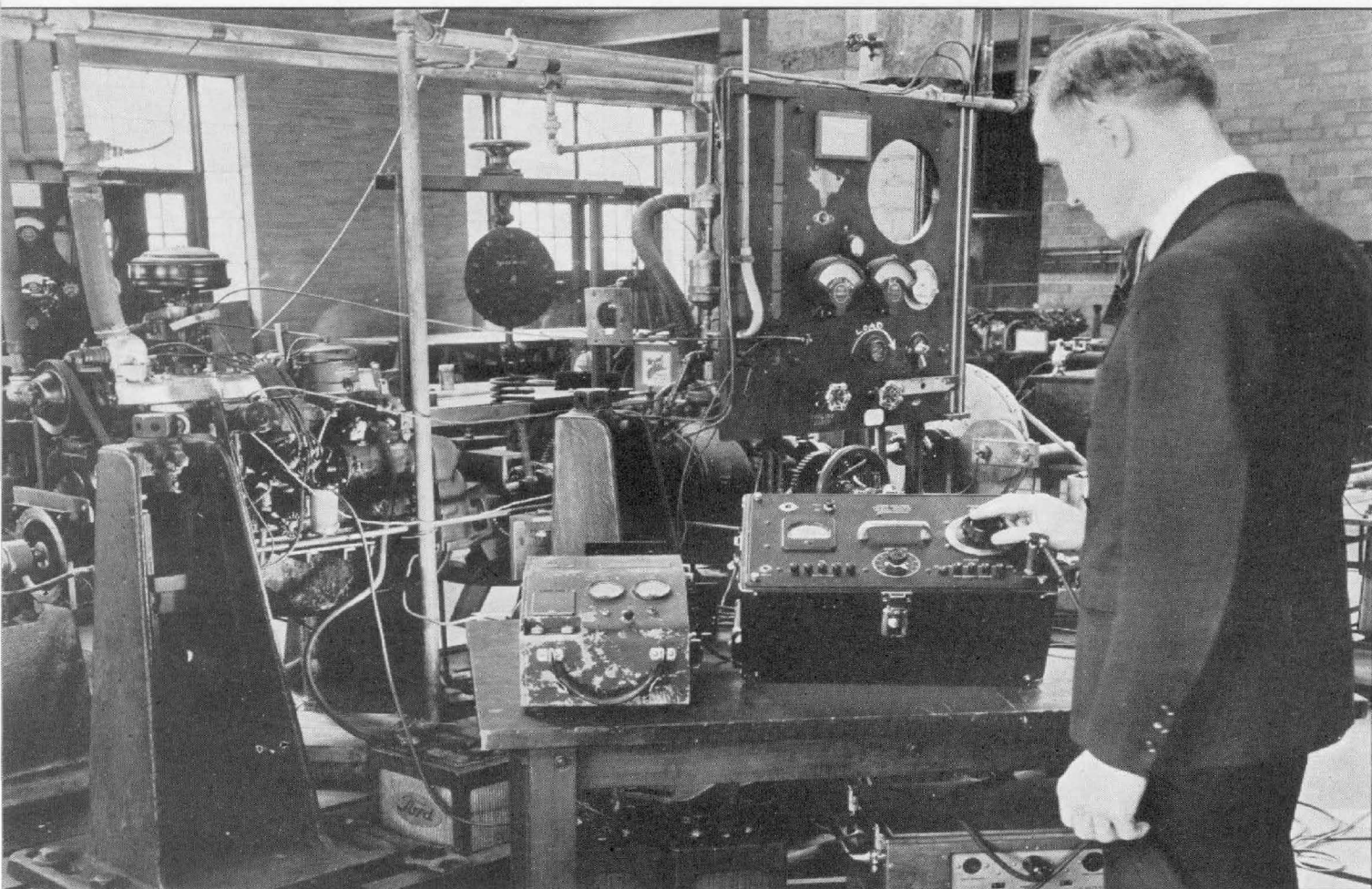

automobile crankshaft through the courtesy of the automotive engineering laboratory at the Massachusetts Institute of Technology has enabled us to compare directly the technique of measurement and the results obtained on the TYPE 760-A Sound Analyzer with those of the older mechanical method. The same vibration pickup and amplifier were used in both methods.

The speed and ease with which the measurement could be made were in marked contrast to the slowness of the older method, while the agreement in results was well within the moment-to-moment fluctuations in the quantity under measurement.

The plot of Figure 2 shows the results of two mechanical analyses and a single analysis with the sound analyzer. The engine was operating at 1800 revolutions per minute (30 revolutions per second).

The three measurements were not taken simultaneously and, consequently, the agreement among the results is influenced by the fact that the amplitudes of the components under measurement are not constant. The results obtained with the TYPE 760-A Sound Analyzer

agree with those of the mechanical method as well as the latter do among themselves.

The outstanding advantage of the sound analyzer is the speed with which the measurement can be made. The complete analysis can be made in about five minutes. With the mechanical analyzer, on the other hand, several minutes are required to evaluate each component in addition to the time consumed in making and developing the oscillogram.

A further advantage lies in the fact that, if the component under measurement varies appreciably, a maximum, a minimum, or an average reading can be taken at will.

There are, of course, a number of applications of this type of measurement outside the automotive industry. Vibration in airplane engines and propellers can be analyzed in the same way. For many machine tools, particularly where vibration would have a direct bearing on product quality, this type of analysis is extremely valuable.

— L. E. PACKARD

**FIGURE 2.**  
Results of the measurements of crankshaft vibration. For purposes of comparison, two mechanical analyses are also plotted.

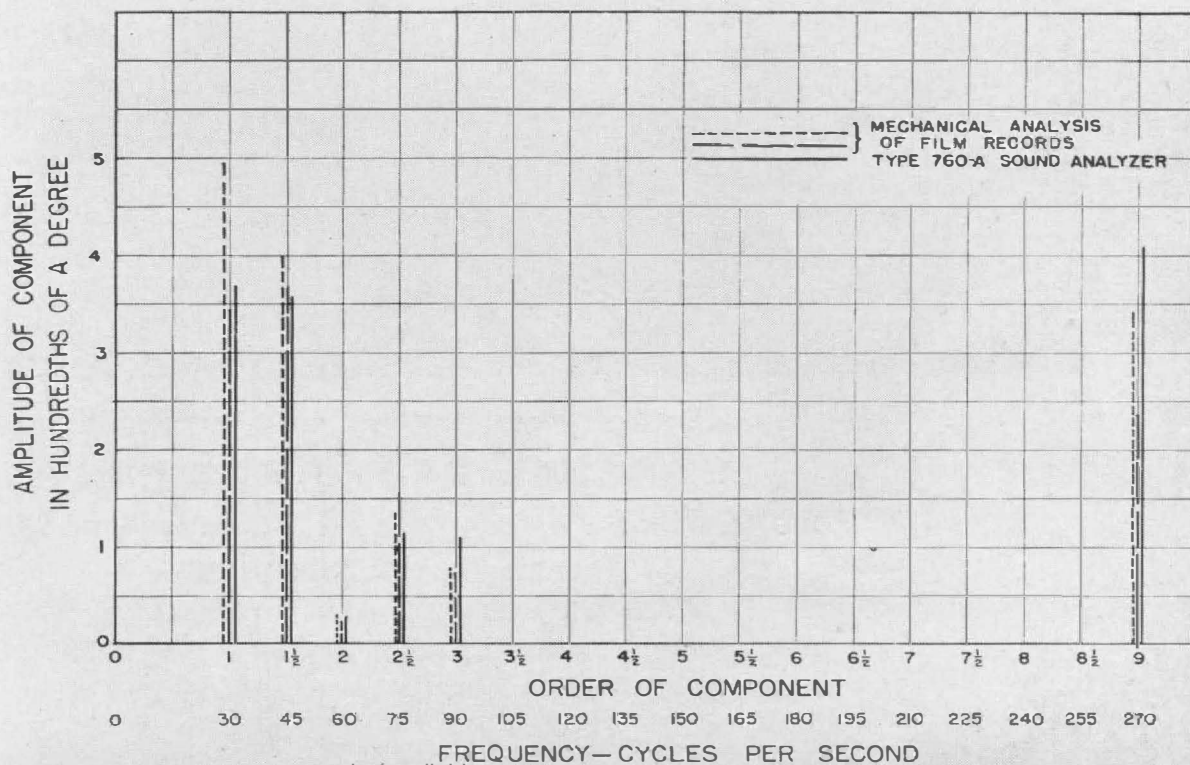



● **TO SHOW THEIR FAMILIES AND FRIENDS** how General Radio products are made, General Radio employees recently held an open house. Guests came in such numbers that the single afternoon originally scheduled was increased to two. Guides conducted the guests around the plant in small groups to allow ample opportunity for questions. Highlight of the program was a hobby

show in which employees exhibited the products of their leisure hours. As the accompanying photographs show, exhibits were many and varied. Among the products of home craftsmen were furniture, telescopes, surf boards and jewelry. The artists showed paintings, drawings, sculpture and photographs. Collectors displayed stamps, coins, historic vacuum tubes and other interesting items.

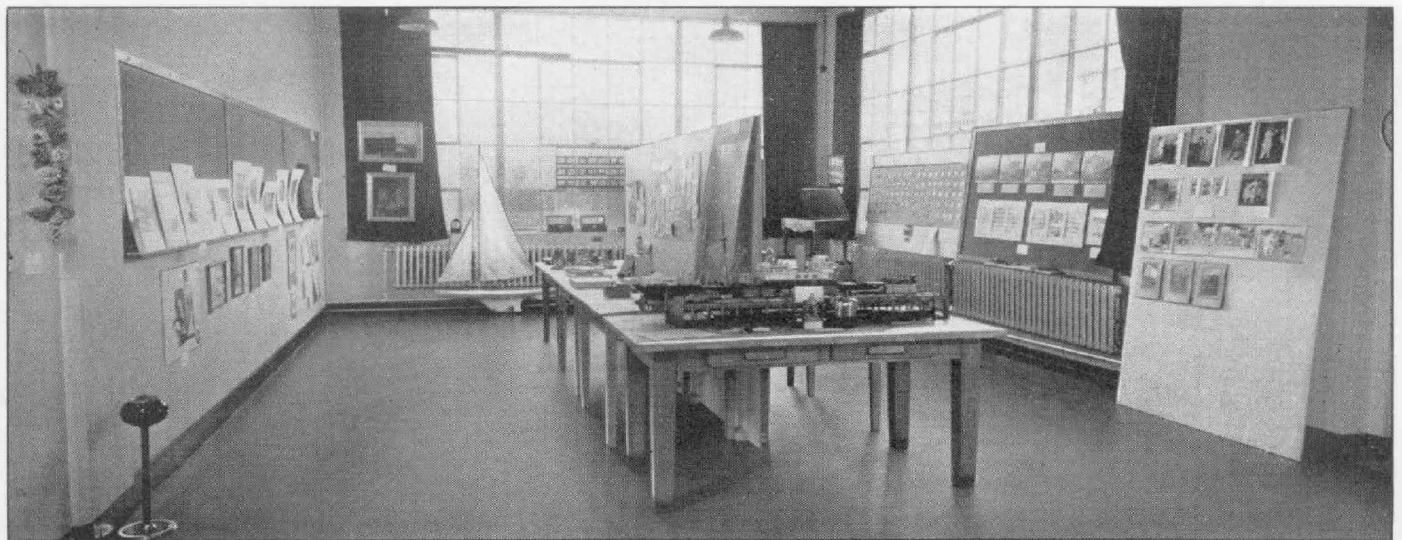

**GENERAL RADIO COMPANY**  
**30 STATE STREET - CAMBRIDGE A, MASSACHUSETTS**  
**BRANCH ENGINEERING OFFICES**  
**90 WEST STREET, NEW YORK CITY**  
**1000 NORTH SEWARD STREET, LOS ANGELES, CALIFORNIA**